

Milesight

AI Motorized Pro Bullet Plus Network Camera

NDA A ✓

IP67 + IK10

Motorized Lens

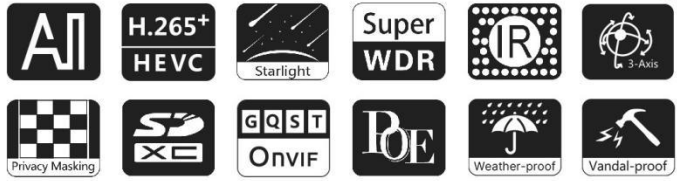

DATASHEET

KEY FEATURES

- ▶ NDA A Compliance (The fully NDA A-compliant products are well suited for government, defense and a range of projects subject to the NDA A.)
- ▶ Smart IR II (Combining the High Beam and Low Beam to adjust IR intensity to fit different lighting conditions.)
- ▶ HLC (High Light Compensation. Improving image visibility under strong light sources.)
- ▶ 140dB Super WDR (Excellent performance even when the ratio of the luminosity of brightest and darkest is up to 140dB.)
- ▶ 90fps High Frame Rate (Camera can easily catch images with no latency despite of the high-speed movement.)
- ▶ 256G (Supporting ultra-large external microSD/SDHC/SDXC card storage up to 256G.)
- ▶ Smart Stream (Bandwidth, storage and bit rate are saved with Smart Stream On, eg, H.265+ saves 70%~80% bandwidth that of H.264.)

AI Video Analytics

- 8 intelligent VCA modes powered by AI engine, which can intelligently filter objects to focus on human and vehicle detection.
- People Counting technology provides high accuracy and real-time data based on AI algorithm with statistic reports.
- Face Detection function detects human faces in the monitoring scene and captures the snapshots, which greatly enhances the monitoring efficiency.



0.002Lux Ultra Low-light

The starlight camera is able to deliver high detailed color images even in low light environment reaching 0.002Lux(Color) or 0Lux(B/W), and near infrared light environments without any supplementary lighting.



30fps@4K

Providing 4K HD resolution with frame rate of 30fps, the camera performs well in catching detailed image regardless of the moving speed.



Integrated Cable Management Bracket

Integrated Cable Management provides easier and faster installation for the users. Versatile interfaces such as PoE, DC, Audio I/O and Alarm I/O are available. The well-designed integrated junction box also makes the cable connection neat and tidy.



AI Motorized Pro Bullet Plus Network Camera



	Model	MS-C4466-RF(I)PE (4MP)	MS-C2966-R(T)F(I)PE (2MP)	MS-C5366-F(I)PE (5MP)
Camera	Image Sensor	1/1.8" Progressive Scan CMOS	1/2.8" Progressive Scan CMOS	
	Min. Illumination	Color: 0.002Lux@F1.4 B/W: 0Lux with IR on	Color: 0.005Lux@F1.4 B/W: 0Lux with IR on	Color: 0.008Lux@F1.4 B/W: 0Lux with IR on
	WDR	140dB Super WDR		120dB Super WDR
	Shutter Time	1/100000s~1s		
	IR Distance	Up to 65m	Up to 65m(3.0~10.5mm/2.7~13.5mm) Up to 100m(7~22mm)	
	Day/Night Mode	Day/Night/Auto/Customize/Schedule		
	S/N	>55dB		
Lens	Lens	Motorized 3.6~10mm@F1.4 P-Iris(Optional)	Motorized 2.7~13.5mm/3.0~10.5mm/7~22mm@F1.4 P-Iris(Optional)	
	Field of View	H100°~H45°/ D116°~D51°/ V57°~V25°	H113°~H33°/D130°~D38° /V60°~V18° (2.7~13.5mm) H104°~H34°/D120°~D39° /V57°~V19° (3.0~10.5mm) H45°~H17°/D53°~D20° /V25°~V9° (7~22mm)	H113°~H33°/D138°~D42° /V83°~V25° (2.7~13.5mm) H94°~H33°/ D116°~D42° / V71°~V25°(3.0~10.5mm) H42°~H16°/D53°~D20° /V32°~V12° (7~22mm)
	Mount	Φ14		
	Focus Control	Auto/Manual		
	Iris Control (Optional for I Series)	Auto/Manual		
Video	Max. Image Resolution	2688x1520	1920x1080	2592x1944
	Primary Stream	60Hz: 60fps@(2688x1520, 2304x1296, 1920x1080, 1280x720) 50Hz: 50fps@(2688x1520, 2304x1296, 1920x1080, 1280x720)	60Hz: 90fps@(1920x1080)(Optional for T Series) , 60fps@(1920x1080, 1280x960, 1280x720, 704x576) 50Hz: 90fps@(1920x1080)(Optional for T Series) , 50fps@(1920x1080, 1280x960, 1280x720, 704x576)	60Hz: 30fps@(2592x1944, 2592x1520, 2048x1536, 1920x1080, 1280x960, 1280x720, 704x576) 50Hz: 25fps@(2592x1944, 2592x1520, 2048x1536, 1920x1080, 1280x960, 1280x720, 704x576)
	Secondary Stream	60Hz: 60fps@(704x576, 640x480, 640x360, 352x288, 320x240) 50Hz: 50fps@(704x576, 640x480, 640x360, 352x288, 320x240)	60Hz: 30fps@(704x576, 640x480, 640x360, 352x288, 320x240) 50Hz: 25fps@(704x576, 640x480, 640x360, 352x288, 320x240)	
	Tertiary Stream	60Hz: 30fps@(1280x720, 704x576, 640x480, 640x360, 320x240) 50Hz: 25fps@(1280x720, 704x576, 640x480, 640x360, 320x240)	60Hz: 30fps@(1920x1080, 1280x720, 704x576, 640x480, 640x360, 352x288, 320x240) 50Hz: 25fps@(1920x1080, 1280x720, 704x576, 640x480, 640x360, 351x288, 320x240)	
	Video Compression	H.265+/H.265(HEVC)/H.264+/H.264/MJPEG		
	Video Bit Rate	16Kbps~16Mbps(CBR/VBR Adjustable)		
	Privacy Masking	Up to 8 Areas (Mask Area and Mosaic Area are optional)		
	ROI	Up to 8 areas		
	Image Setting	Brightness/Contrast/Saturation/Sharpness		
Interface	Ethernet	1*RJ45 10M/100M Ethernet Port		
	Audio I/O	1/1		
	Alarm I/O	1/1		

AI Motorized Pro Bullet Plus Network Camera



Network	Network Storage	NAS(Support NFS, SMB/CIFS), ANR
	Protocol	IPv4/IPv6, ARP, TCP, UDP, RTCP, RTP, RTSP, RTMP, HTTP, HTTPS, DNS, DDNS, DHCP, FTP, NTP, SMTP, SNMP, UPnP, Bonjour, SIP, PPPoE, VLAN, 802.1x, QoS, IGMP, ICMP, SSL
Audio	Audio Compression	G.711/AAC/G.722/G.726
	Audio Sampling Rate	8/16/32/44.1/48KHz
	Audio Bit Rate	16~256kbps
	Two-way Audio	Support
Intelligent Analytics	Video Analysis	Region Entrance, Region Exiting, Advanced Motion Detection, Tamper Detection, Line Crossing, Loitering, Object Left, Object Removed
	Face Detection&Face Attribute Recognition	Detect and capture faces, get real-time snapshots; The attributes include Age, Gender, Glasses, Mask and Cap; Support Faces Privacy Mode, the detected faces in the face detection area will be mosaic automatically.
	People Counting&Report	Count the number of people entering or exiting, up to 4 detection areas for regional people counting
System	Storage	Support microSD/SDHC/SDXC Card Local Storage, up to 256G
	Advanced Function	Heat Map, BLC, HLC, 2D DNR, 3D DNR, Defog, AWB, IP Address Filtering, AGC, Anti-flicker, Corridor Mode, Deblur, Watermark
	SIP/VoIP Support	Yes, Voice & Video-over-IP
	Event Trigger	Motion Detection, Network Disconnection, External Input, Audio Alarm, etc.
	Event Action	FTP Upload, SMTP Upload, SD Card Record, External Output, SIP Phone, HTTP Notification, etc.
	System Compatibility	ONVIF Profile G & Q & S & T, API
General	Working Temperature	-40°C~60°C
	Working Humidity	0~95%(Non-condensing)
	Power Supply	PoE (802.3af) / DC 12V±10%
	Power Consumption	6W MAX 8W MAX(With IR on)
	Housing	Vandal-proof IK10-rated Metal Housing / Up to IP67-rated for Weather-resistant Performance
	Surge Protection	4KV
	Weight	1630g
	Dimensions	301mmX108mmX126mm
	Warranty	3/5 Years

AI Motorized Pro Bullet Plus Network Camera



	Model	MS-C8166-F(I)PE (4K)	MS-C8266-F(I)PE (4K)
Camera	Image Sensor	1/2.8" Progressive Scan CMOS	1/1.8" Progressive Scan CMOS
	Min. Illumination	Color: 0.012Lux@F1.4 B/W: 0Lux with IR on	Color: 0.009Lux@F1.4 B/W: 0Lux with IR on
	WDR	120dB Super WDR	
	Shutter Time	1/100000s~1s	
	IR Distance	Up to 65m	
	Day/Night Mode	Day/Night/Auto/Customize/Schedule	
	S/N	>55dB	
Lens	Lens	Motorized 2.7~13.5mm@F1.4 P-Iris(Optional)	Motorized 3.6~10mm@F1.4 P-Iris(Optional)
	Field of View	H110°~H33°/D118°~D38°/V60°~V18°	H116°~H48°/D134°~D55°/V65°~V27°
	Mount	Φ14	
	Focus Control	Auto/Manual	
	Iris Control (Optional for I Series)	Auto/Manual	
Video	Max. Image Resolution	3840x2160	
	Primary Stream	60Hz: 30fps@(3840x2160, 3072x2048, 2592x1944, 2592x1520, 2048x1536, 1920x1080, 1280x960, 1280x720, 704x576) 50Hz: 25fps@(3840x2160, 3072x2048, 2592x1944, 2592x1520, 2048x1536, 1920x1080, 1280x960, 1280x720, 704x576)	
	Secondary Stream	60Hz: 30fps@(704x576, 640x480, 640x360, 352x288, 320x240) 50Hz: 25fps@(704x576, 640x480, 640x360, 352x288, 320x240)	
	Tertiary Stream	60Hz: 30fps@(1920x1080, 1280x720, 704x576, 640x480, 640x360, 320x240) 50Hz: 25fps@(1920x1080, 1280x720, 704x576, 640x480, 640x360, 320x240)	
	Video Compression	H.265+/H.265(HEVC)/H.264+/H.264/MJPEG	
	Video Bit Rate	16Kbps~16Mbps(CBR/VBR Adjustable)	
	Privacy Masking	Up to 8 Areas (Mask Area and Mosaic Area are optional)	
	ROI	Up to 8 areas	
Image Setting	Brightness/Contrast/Saturation/Sharpness		
Interface	Ethernet	1*RJ45 10M/100M Ethernet Port	
	Audio I/O	1/1	
	Alarm I/O	1/1	
Network	Network Storage	NAS(Support NFS, SMB/CIFS), ANR	
	Protocol	IPv4/IPv6, ARP, TCP, UDP, RTCP, RTP, RTSP, RTMP, HTTP, HTTPS, DNS, DDNS, DHCP, FTP, NTP, SMTP, SNMP, UPnP, Bonjour, SIP, PPPoE, VLAN, 802.1x, QoS, IGMP, ICMP, SSL	

AI Motorized Pro Bullet Plus Network Camera



Audio	Audio Compression	G.711/AAC/G.722/G.726	
	Audio Sampling Rate	8/16/32/44.1/48KHz	
	Audio Bit Rate	16~256kbps	
	Two-way Audio	Support	
Intelligent Analytics	Video Analysis	Region Entrance, Region Exiting, Advanced Motion Detection, Tamper Detection, Line Crossing, Loitering, Object Left, Object Removed	
	Face Detection&Face Attribute Recognition	Detect and capture faces, get real-time snapshots; The attributes include Age, Gender, Glasses, Mask and Cap; Support Faces Privacy Mode, the detected faces in the face detection area will be mosaic automatically.	
	People Counting& Report	Count the number of people entering or exiting, up to 4 detection areas for regional people counting	
System	Storage	Support microSD/SDHC/SDXC Card Local Storage, up to 256G	
	Advanced Function	Heat Map, BLC, HLC, 2D DNR, 3D DNR, Defog, AWB, IP Address Filtering, AGC, Anti-flicker, Corridor Mode, Deblur, Watermark	
	SIP/VoIP Support	Yes, Voice & Video-over-IP	
	Event Trigger	Motion Detection, Network Disconnection, External Input, Audio Alarm, etc.	
	Event Action	FTP Upload, SMTP Upload, SD Card Record, External Output, SIP Phone, HTTP Notification, etc.	
	System Compatibility	ONVIF Profile G & Q & S & T, API	
General	Working Temperature	-40°C~60°C	
	Working Humidity	0~95%(Non-condensing)	
	Power Supply	PoE (802.3af) / DC 12V±10%	
	Power Consumption	7W MAX 9W MAX(With IR on)	6W MAX 8W MAX(With IR on)
	Housing	Vandal-proof IK10-rated Metal Housing / Up to IP67-rated for Weather-resistant Performance	
	Surge Protection	4KV	
	Weight	1630g	
	Dimensions	301mmX108mmX126mm	
	Warranty	3/5 Years	

AI Motorized Pro Bullet Plus Network Camera



Structure Diagrams

microSD/SDHC/SDXC Card Slot

Reset

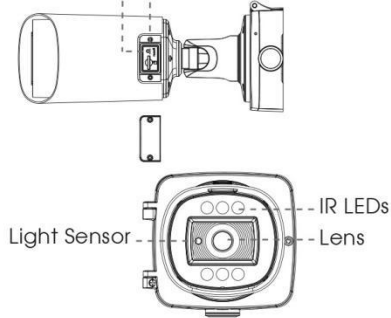

Ethernet Port (PoE)

Alarm/Audio

DC 12V

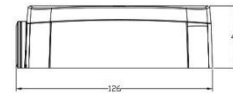
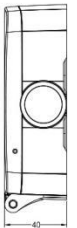
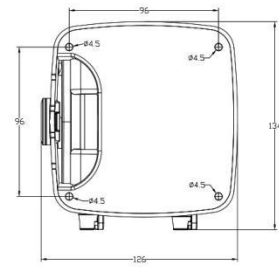
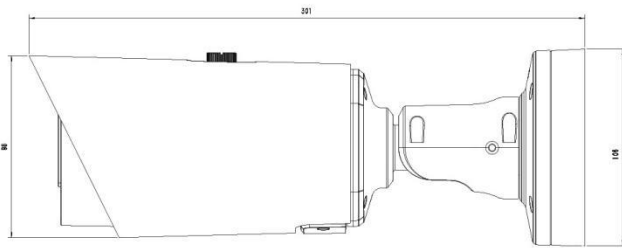
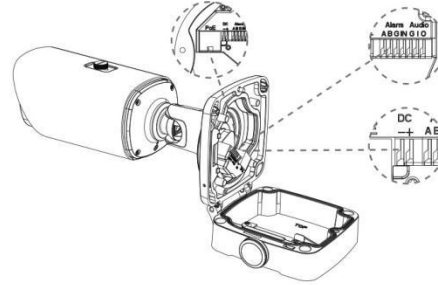

Units: mm

Accessories Support

A62 Junction Box(Default)

Weight: 510g
Dimensions: 134*126*40mm



A01 Pole Mount

Weight: 720g
Dimensions: 170*51.5*152.6mm



A03 External Corner Bracket

Weight: 900g
Dimensions: 170*152.5*76.3mm



Mlesight | www.mlesight.com

Contact Us: sales@mlesight.com support@mlesight.com

Add: 220 NE 51st Street, Oakland Park, Florida 33334, USA
Tel: +1-800-561-0485

Add: 925, Anyang SK V1 Center, LS-ro 116beon-gil, Dongan-gu, Anvang-si, Korea
Tel: +82-31-990-7732

Add: Building C09, Software Park Phase III, Xiamen 361024, Fujian, China
Tel: +86-592-5922772

