

Entrance & Exit AI LPR Pro Bullet Plus Camera

IP67 +IK10

Motorized Lens

DATASHEET



KEY FEATURES

- ▶ Superior Image Quality (Starlight Sensor, Smart IR II Technology and high frame rate are supported for an excellent image quality.)
- ▶ LPR Smart Search (Relevant videos can be found quickly by searching for only a portion of the target suspect vehicle's features, such as vehicle type & color, plate color, plate number, direction and etc.)

Intelligent AI-powered LPR Algorithm

Entrance & Exit AI LPR Camera can not only recognize vehicle plates in real time, but also identify more vehicle features, like vehicle type, color, etc., generating reliable traffic insights to improve safety and mobility.



Evidence Camera Linkage

Entrance & Exit AI LPR Camera can link with any regular cameras to capture the evidence. Thanks to the seamless trigger between the LPR camera and the regular camera, users can easily provide solid and convincing evidence with LPR results together with overview snapshots and critical details.



Black and White List and No-plate Event

Entrance & Exit AI LPR Camera enable to achieve stand-alone solutions for license plate recognition as well as no-plate vehicle detection. Alarm is triggered as soon as the corresponding rule-compliant license plate is detected, enabling efficient and accurate access control at any gate.

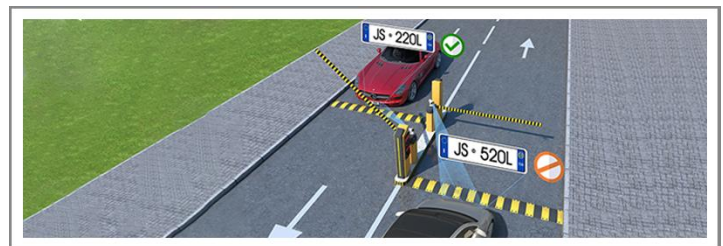

Easy and Flexible Deployment

Milesight Entrance & Exit AI LPR Cameras enable a standalone license plate recognition solution for fast implementation scenarios with high efficiency and accuracy. It can also be used with NVR, CMS and VMS Enterprise, to form a fully closed-loop traffic solution.

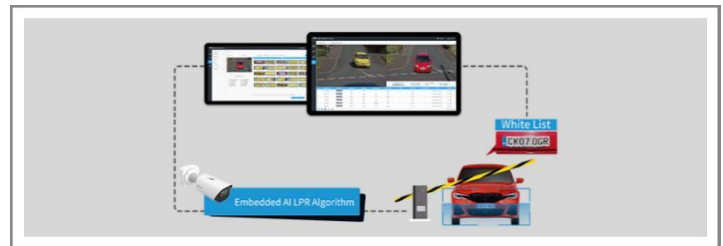

Entrance & Exit AI LPR Pro Bullet Plus Camera



	Model	MS-C2966-RFLPE (2MP)
Camera	Image Sensor	1/2.8" Progressive Scan CMOS
	Min. Illumination	Color: 0.005Lux@F1.4 B/W: 0Lux with IR on
	WDR	140dB Super WDR
	Shutter Time	1/100000s~1s
	Day/Night Mode	Day/Night/Auto/Customize/Schedule
	Illumination Distance	Up to 65m
	S/N	>55dB
Lens	Lens	Motorized 2.7~13.5mm@F1.4
	Field of View	H115°~H34°/D135°~D39°/V62°~V19°
	Mount	Φ14
	Focus Control	Auto/Manual
Entrance & Exit Management	Max. Vehicle Speed	100km/h
	Recognition Accuracy	>98%
	Coverage	2 lanes
	Country/Region Supported	More than 80 countries and regions
	ANPR Distance	Up to 25m during the day; Up to 20m during the night with illumination
	Attributes Identification	Plate Color, Vehicle Type, Vehicle Color, Vehicle Brand, No-plate Vehicle Capture, Vehicle Direction Detection
	Smart Traffic Function	Evidence Camera Linkage
	White/Black List	Up to 20,000 records inside the camera
	LPR Smart Search	Support
Interface	Ethernet	1*RJ45 10M/100M Ethernet Port
	Audio I/O	1/1
	Alarm I/O	1/1
Video	Max. Image Resolution	1920x1080
	Primary Stream	60Hz: 60fps@(1920x1080, 1280x960, 1280x720, 704x576) 50Hz: 50fps@(1920x1080, 1280x960, 1280x720, 704x576)
	Secondary Stream	60Hz: 60fps@(704x576, 640x480, 640x360, 352x288, 320x240) 50Hz: 50fps@(704x576, 640x480, 640x360, 352x288, 320x240)
	Tertiary Stream	60Hz: 30fps@(1920x1080, 1280x720, 704x576, 640x480, 640x360, 320x240) 50Hz: 25fps@(1920x1080, 1280x720, 704x576, 640x480, 640x360, 320x240)
	Video Compression	H.265+/H.265(HEVC)/H.264+/H.264/MJPEG
	Video Bit Rate	16Kbps~16Mbps(CBR/VBR Adjustable)
	Privacy Masking	Up to 8 Areas (Mask Area and Mosaic Area are optional)
	ROI	Up to 8 areas
	Image Setting	Brightness/Contrast/Saturation/Sharpness

Entrance & Exit AI LPR Pro Bullet Plus Camera



Network	Network Storage	NAS(Support NFS, SMB/CIFS), ANR
	Protocol	IPv4/IPv6, ARP, TCP, UDP, RTCP, RTP, RTSP, RTMP, HTTP, HTTPS, DNS, DDNS, DHCP, FTP, NTP, SMTP, SNMP, UPnP, Bonjour, SIP, PPPoE, VLAN, 802.1x, QoS, IGMP, ICMP, SSL
Audio	Audio Compression	G.711/AAC/G.722/G.726
	Audio Sampling Rate	8/16/32/44.1/48KHz
	Audio Bit Rate	16~256kbps
	Two-way Audio	Support
System	System Compatibility	API, HTTP, TCP, ONVIF Profile G & M & S & T
	Storage	microSD/SDHC/SDXC Card Local Storage, up to 1TB
	Advanced Function	BLC, HLC, 2D DNR, 3D DNR, Defog, AWB, IP Address Filtering, AGC, Anti-flicker, Corridor Mode, Deblur, Watermark
	SIP/VoIP Support	Yes, Voice & Video-over-IP
	Event Trigger	Black/White List, Motion Detection, Network Disconnection, External Input, Audio Alarm, etc.
	Event Action	FTP Upload, SMTP Upload, SD Card Record, External Output, SIP Phone, HTTP Notification, etc.
General	Working Temperature	-40°C~60°C
	Working Humidity	0~95%(Non-condensing)
	Power Supply	PoE (802.3af) / DC 12V±10%
	Power Consumption	6W MAX 8W MAX (With IR on)
	Weather Proof	Up to IP67-rated for Weather-resistant Performance
	Housing	Vandal-proof IK10-rated Metal Housing
	Weight	1630g
	Dimensions	301mmX108mmX126mm
	Warranty	3/5 Years



Structure Diagrams

microSD/SDHC/SDXC Card Slot

Reset

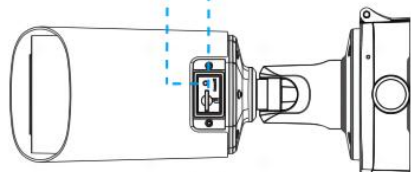

Light Sensor

IR LEDs

Lens

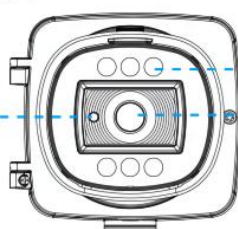

Ethernet Port(PoE)

Alarm /Audio

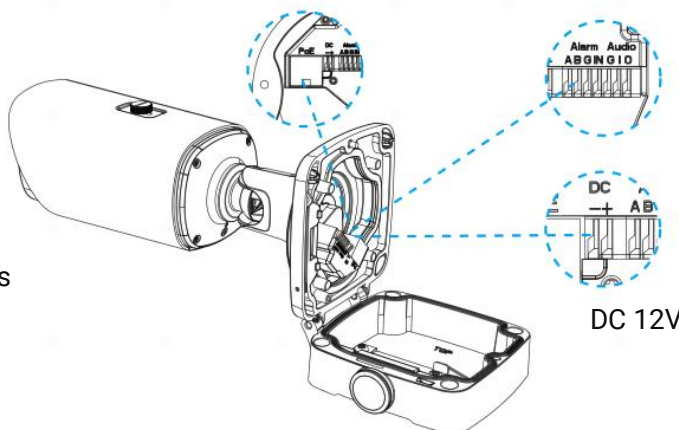

DC 12V

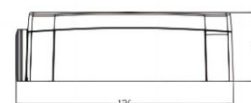
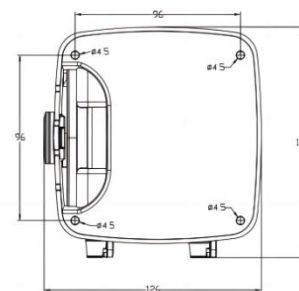
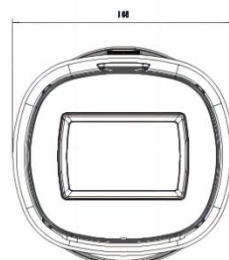
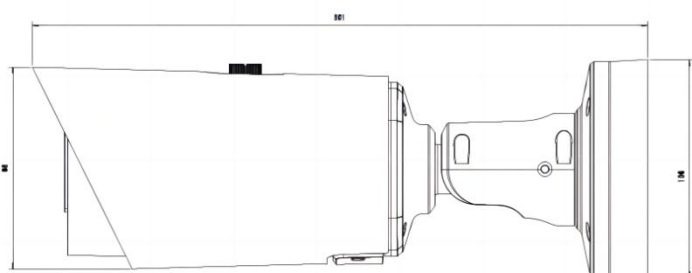

Units: mm

Accessories Support

A62 Junction Box (Default)

Weight: 510g

Dimensions: 134*126*40mm



A01 Pole Mount

Weight: 720g

Dimensions: 170*51.5*152.6mm



A03 External Corner Bracket

Weight: 900g

Dimensions: 170*152.5*76.3mm

