

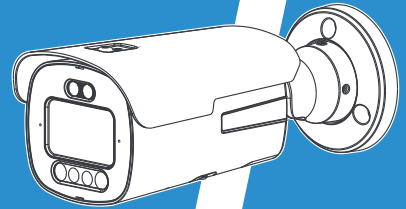

## QUICK START GUIDE

AI Motorized TrueColor Bullet Network Camera



User Manual



Smart Tools

**Milesight** | *Make Sensing Matter*

🏠 Milesight IoT Co., Ltd. 🌐 [www.milesight.com/security](http://www.milesight.com/security)

---

## Table of Contents

1. Package Contents.....	2
2. Hardware Overview.....	3
3. Dimensions .....	4
4. Installation.....	5
5. How to Connect to Alarm Interface.....	9
6. How to Connect the Water-proof Connector.....	10
7. Assigning an IP Address by Using Smart Tools.....	10
8. Assigning an IP Address via Browser.....	11
9. Accessing from the Web Browser.....	11
10. FCC Statement.....	12

## 1. Package Contents



AI Motorized TrueColor  
Bullet Network Camera



Expansion Screw  
Packet x 1



Hex Torx Screwdriver x 1



Water-proof  
Connector x 1



Quick Start Guide x 1



Warranty Card x 1



Perforation-assisted  
Sticker x 1

## 2. Hardware Overview

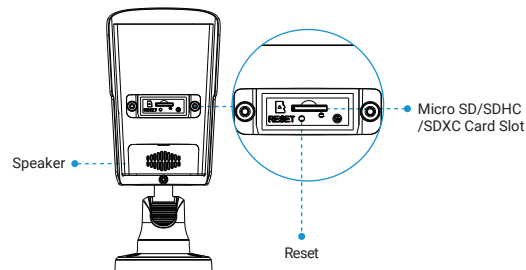
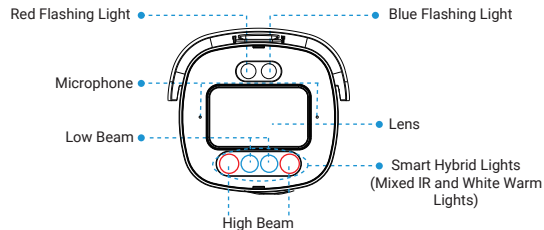

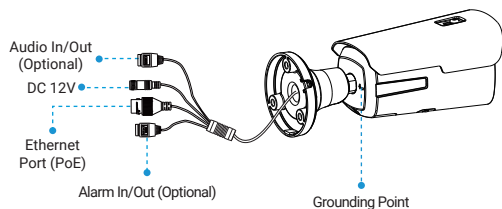

### 3. Dimensions

#### AI Motorized TrueColor Bullet Network Camera

Units: mm

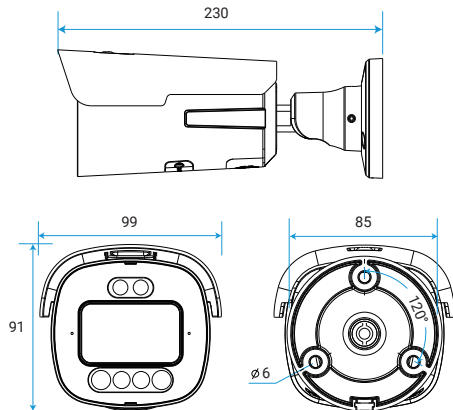

### 4. Installation

**Step1:** First, fix the perforation-assisted sticker at the camera's intended installation position, then punch holes as indicated on the sticker.

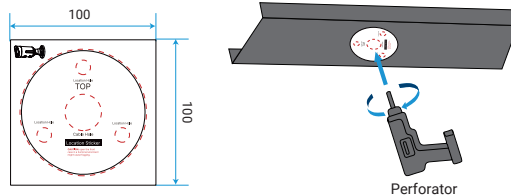

**Step2:** Pass cables through the designated Cable Hole indicate on the perforation-assisted sticker.

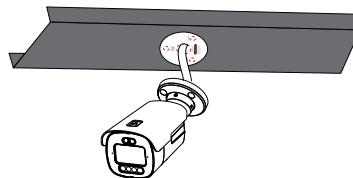

**Step3:** After aligning the camera's hole with the positioning holes, secure the camera by tightening the screws.

Optional mounting accessories include Pole Mount (A01 V3), External Corner Bracket (A03), and Junction Box (A63).

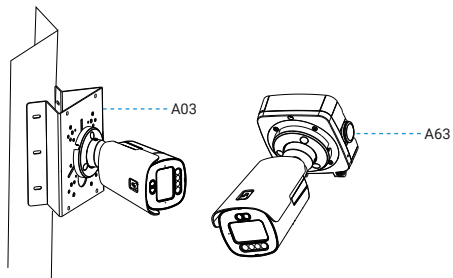
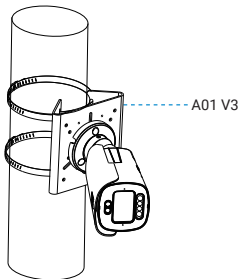
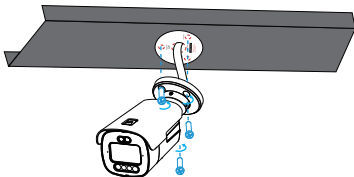

**Step4:** Power the camera using either the Ethernet port (PoE) or the DC 12V power supply port. Then, loosen the limit screw to adjust the camera to the desired direction.

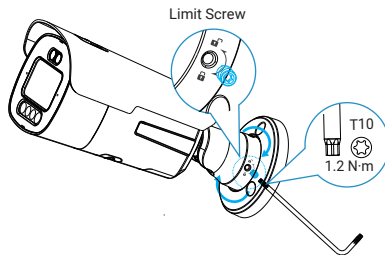

Tips: Use a hex Torx screwdriver. The recommended torque is 1.2 N·m

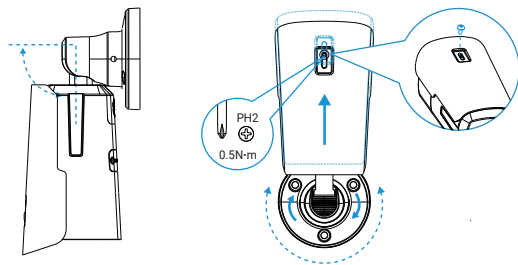

Vertical Rotation: 0° to 90°

Horizontal Rotation: 0° to 360°

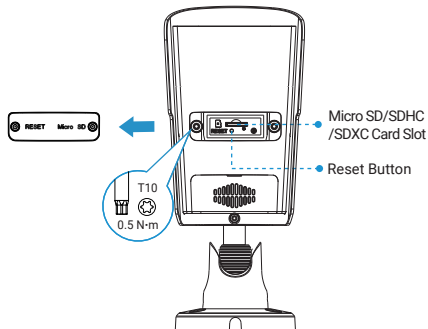
**Note:**

- ① Loosen the screws of SD Card structure to get access to the SD Card slot if you need.
- ② Reset Button: Press "Reset" button 5 seconds, then the device will be restored to factory default.
- ③ Fix the screw again after inserting the SD Card to complete the operation.
- ④ If the camera is installed outdoors, you can move the rain cover further forward.
- ⑤ During installation, straighten the release cord and avoid twisting or knotting it.

**Step5:** Finish the installation.

## 5. How to Connect to Alarm Interface

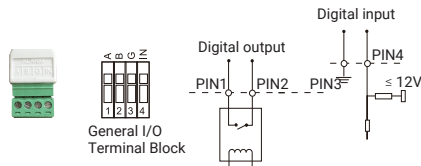
**PIN1:** Alarm Output NC/NO 24V DC 1A**PIN2:** Alarm Output NC/NO 24V DC 1A**PIN3:** Alarm Input NC/NO ≤ 12V**PIN4:** Alarm Input NC/NO ≤ 12V

## 6. How to Connect the Water-proof Connector

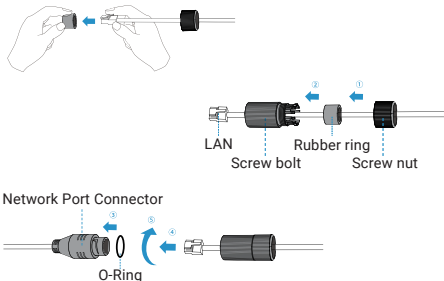

**Step1:** Get the network cable through the screw nut, rubber ring and the screw bolt;

**Step2:** Insert the rubber ring into the screw bolt;

**Step3:** Connect the screw nut to the screw bolt;

**Step4:** Place the O-Ring on the network port connector;

**Step5:** Connect the RJ45 to the network port connector, tighten the screw bolt and the connector.

### Note:

Please tightly wrapped all cable-out interface with adhesive tape at last to prevent them from water.

## 7. Assigning an IP Address by Using Smart Tools

Smart Tools is a software tool which can automatically detect multiple online Milesight network cameras in the LAN, set IP addresses, and manage firmware upgrades. It's recommended to use when assigning IP addresses for multiple cameras.

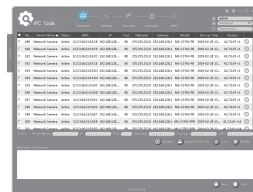

The steps to change the IP of cameras are as below:

- 1) Start Smart Tools, click the IPC Tools page, then enter the device information, such as IP address, MAC address, Port number, Netmask, and Gateway, then all related Milesight network cameras in the same network that will be shown.
- 2) Select a camera or multiple cameras according to the MAC addresses.
- 3) Click "Activate" to set the password when using the cameras for the first time (Password must be 8 to 32 characters long, contain at least one number and one letter), and set three security questions (If you forget the password, you can reset the password by answering three security questions correctly).
- 4) Type the user name and password you set, change the IP address or other network values, and then click "Modify" button.
- 5) By double clicking the selected camera or the browser of interested camera, you can access the camera via web browser directly.

More usage of Smart Tools, please refer to the "[Smart Tools User Manual](#)".

## 8. Assigning an IP Address via Browser

If the network segment of the computer and that of the camera are different, please add some 192.168.5.xx (255.255.255.0) for your PC to access to your cameras, more details can be found on "[Milesight Network Camera Quick Start](#)".

## 9. Accessing from the Web Browser

The camera can be used with the most standard operating systems and browsers. The recommended browsers are Internet Explorer, Firefox, Chrome and Safari. More information about the plug-in installation, please refer to the troubleshooting:

5. [Milesight-Troubleshooting-Plugin Installation on Windows-IPC](#)
6. [Milesight-Troubleshooting-Plugin Installation on MAC](#)

## 10. FCC Statement

Any changes or modifications not expressly approved by the party responsible for compliance could void the user's authority to operate the equipment.

This device complies with part 15 of the FCC Rules. Operation is subject to the following two conditions:

- (1) This device may not cause harmful interference, and
- (2) This device must accept any interference received, including interference that may cause undesired operation.

**Note:** This equipment has been tested and found to comply with the limits for a Class B digital device, pursuant to part 15 of the FCC Rules. These limits are designed to provide reasonable protection against harmful interference in a residential installation. This equipment generates, uses and can radiate radio frequency energy and, if not installed and used in accordance with the instructions, may cause harmful interference to radio communications. However, there is no guarantee that interference will not occur in a particular installation. If this equipment does cause harmful interference to radio or television reception, which can be determined by turning the equipment off and on, the user is encouraged to try to correct the interference by one or more of the following measures:

- Reorient or relocate the receiving antenna.
- Increase the separation between the equipment and receiver.
- Connect the equipment into an outlet on a circuit different from that to which the receiver is connected.
- Consult the dealer or an experienced radio/TV technician for help.

### **FCC Radiation Exposure Statement:**

This equipment complies with FCC radiation exposure limits set forth for an uncontrolled environment. This equipment should be installed and operated with minimum distance 20cm between the radiator& your body. This transmitter must not be co-located or operating in conjunction with any other antenna or transmitter.

产品型号	B6802	版本	V2.0
名称	英文版手册	料号	43.005.000273
比例	1:1	单位	mm
IQC检验尺寸	①②③....		
尺寸	<input type="checkbox"/> 63x63mm	公差等级	<input type="checkbox"/> GBT1804-f
	<input type="checkbox"/> 84x84mm		<input checked="" type="checkbox"/> GBT1804-m
	<input checked="" type="checkbox"/> 120x85mm		<input type="checkbox"/> GBT1804-c
	<input type="checkbox"/> 其他		<input type="checkbox"/> GBT1804-v
材质	<input type="checkbox"/> 80g双胶纸		
	<input checked="" type="checkbox"/> 200g铜版纸+80g双胶纸		
文档类型/相关技术要求			
<p>技术要求:</p> <p>1.封面覆哑膜（翻页）；</p> <p>2.手册不允许有明显的损坏和污迹，印刷内容需位置准确且清晰；</p> <p>3.手册不应存在拼接部分，不应有多余的压痕线。</p>			
版本	设变人员/日期	设变描述	
V1.0		新订	
V2.0	张恒韬/20260326	文案更新	
V3.0			
设计/日期	张恒韬/20260326	样品确认/日期	
审核/日期		批准/日期	